

RAHIM HASANOV

TASVIRIY SAN'AT

1-SINF UCHUN DARSLIK

Qayta ishlangan 16-nashri

O'zbekiston Respublikasi Xalq ta'limi vazirligi
nashrga tavsiya etgan

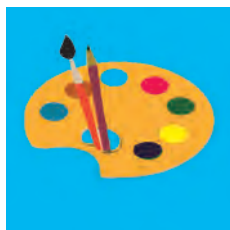

G'afur G'ulom nomidagi nashriyot-matbaa ijodiy uyi
Toshkent – 2018

UO'K 741 (075)

KBK 74.268.51

H 12

Mas'ul muharrir

Asqarali Sulaymonov – pedagogika fanlari nomzodi

Taqrizchilar:

R. Xudoyberganov – Kamoliddin Behzod nomidagi Milliy rassomchilik va dizayn instituti professori;

G. Zulxaydarova – Respublika Ta'lim markazi metodisti;

T. Mansurov – Toshkent viloyati Chinoz tumanidagi 40-maktab o'qituvchisi.



– topshiriqlar.



– uyga vazifa.



– dars tugadi.

**Respublika maqsadli kitob jamg'armasi
mablag'lari hisobidan chop etildi.**

Hasanov R.

Tasviriy san'at. 1-sinf uchun darslik. Qayta ishlangan 16-nashri. –
T.: G'afur G'ulom nomidagi nashriyot-matbaa ijodiy uyi, 2018. – 56 b.

**UO'K 741 (075)
KBK 74.268.51**

© **Rahim Hasanov**
© **G'afur G'ulom nomidagi**
nashriyot-matbaa ijodiy
uyi, 2018

ISBN 978-9943-5215-0-6

TASVIRIY SAN'AT TURLARI

Rangtasvir



R. Xudoyberganov. **Sijjakda kuz.**



Laylo Salimjonova. **Hamro Rahimova.**



Baxtiyor Olimxonov. **Natyurmort.**

Haykaltaroshlik



R. Mirtojiev. **Mirzo Ulug'bek.**

Grafika



Vladimir Parshin.
Salom.



Bayram.



Qutlug' Basharov. **Kamondan o'q otish**



RASSOMNING ISH QUROLLARI

Qalam va mo'yqalamlar

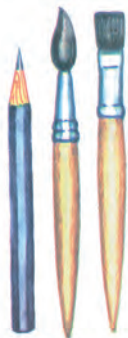

Akvarel bo'yoqlar



Rangli qalamlar

Suv idish

O'chirg'ich



Palitra



Guash bo'yoqlar

Ish o'rnini tashkil etish





CHIZIQLAR VA SHAKLLAR



Bu rasmlar shakllardan tashkil topgan.

Tasvirlar va shakllar

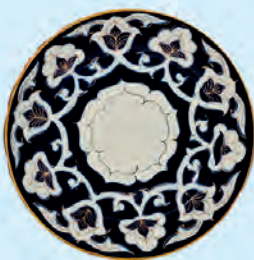

Doira



To'rtburchak



Kvadrat



Uchburchak



Shakllarning nomlarini ayting.

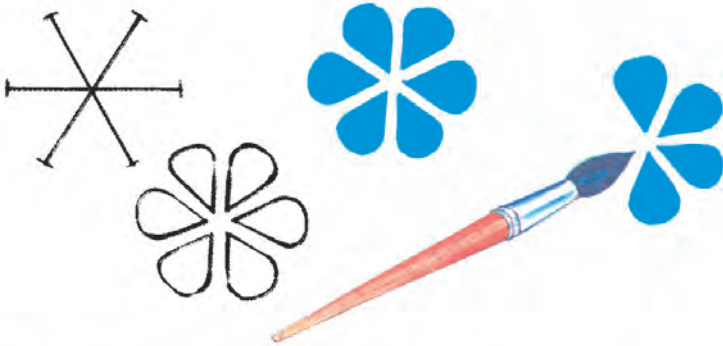
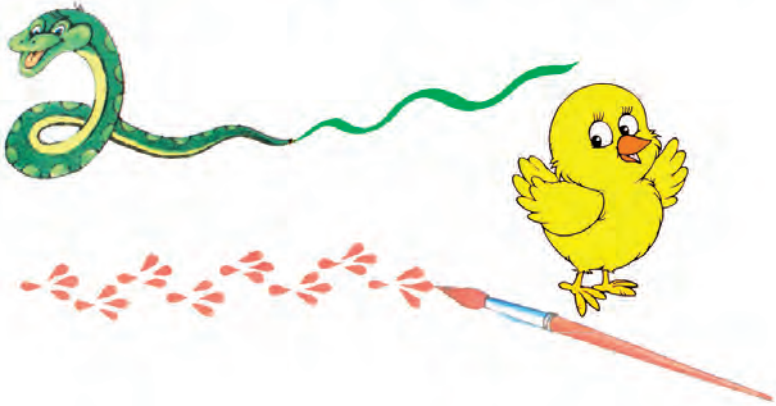

BO'YOQLAR VA RANGLAR

Akvarel va guash bo'yoqlar



Ranglar



Sariq



Oq



Qizil



Qora



Zarg'aldoq

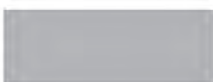

Kulrang



Ko'k



Jigarrang



Yashil



Binafsha



Asosiy ranglar

Qizil

Sariq



Ko'k



Asosiy ranglardan boshqa ranglar
hosil qilish

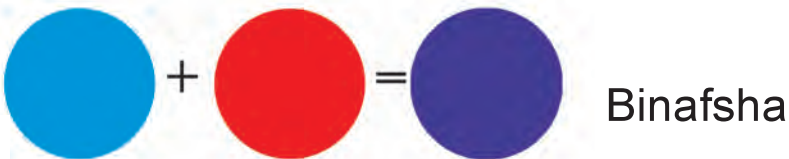

BAYROQCHA RASMINI ISHLASH

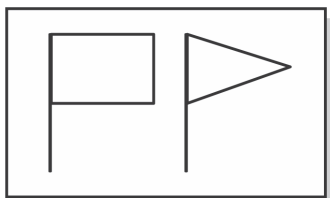
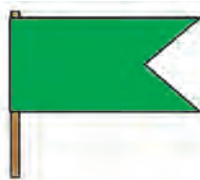
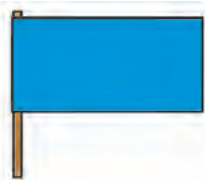

to'g'ri



noto'g'ri

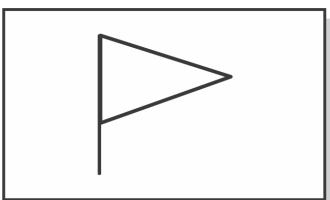

to'g'ri

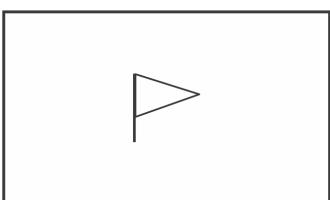

noto'g'ri

1

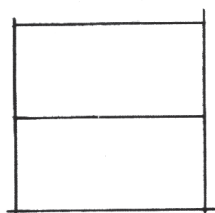

2

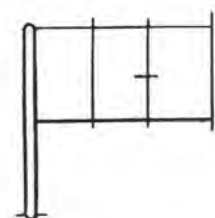

3

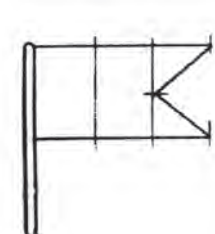

4



SOAT RASMINI ISHLASH

Soatlar har xil shaklda bo'ladi.



Soat rasmi shunday ishlanadi.

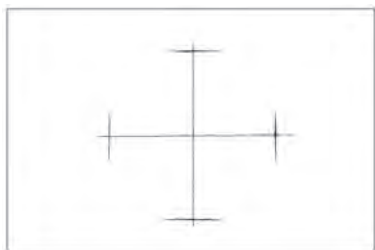

1

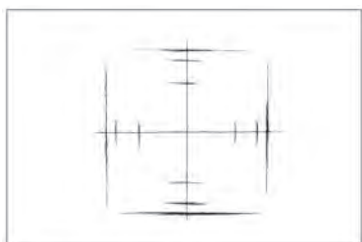

2

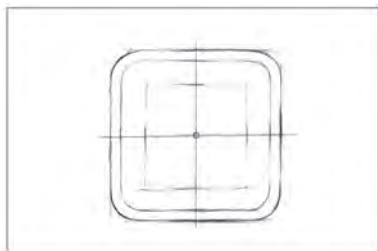

3

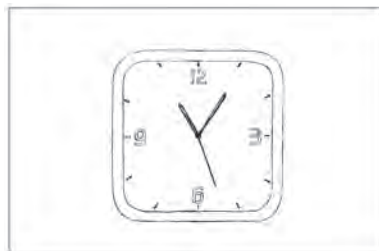

4



KUZ FASLINI IDROK ETISH



I. Haydarov. **Oltin kuz.**



Abduvali Mo'minov. **Manzara.**



V. Polenov. **Oltin kuz.**

«KUZ» MAVZUSIDA RASM ISHLASH



Erta kuz



O'рта kuz



Kech kuz

Kuzda tabiat har xil
ko'rinishda bo'ladi.



BARGLAR RASMINI ISHLASH



Barglarning shakllari va ranglari
har xil bo'ladi.

Barg rasmi shunday chiziladi:

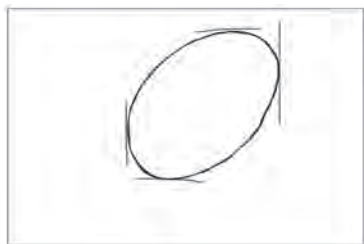

1

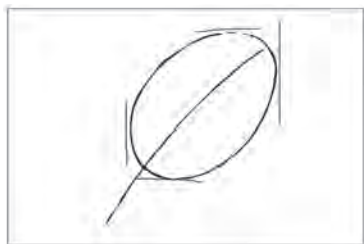

2

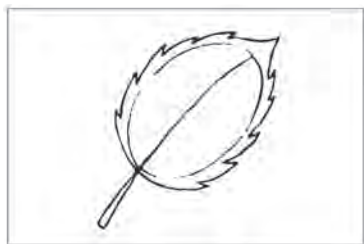

3



4

Barg rasmi shunday bo'yaladi:



1



2



3



BARGLARDAN TASVIR VA SHAKLLAR HOSIL QILISH



Siz ham yuqoridagilar kabi barglardan
birorta jonivor tasvirini yasang.



HAYKAL ISHLASH

Steklar

Plastilin





Georgiy Ulko. **Usta Umarqul Jo'raqulov.**



Ustaning ishlaridan namunalar.



Hunarmandchilik ishlaridan namunalar.

O'yinchoq haykalcha quyidagicha yasaladi:



AKVARIUMDAGI BALIQLAR RASMINI ISHLASH



Baliqlar tuzilishi va rangi jihatidan turlicha bo'ladi.

Baliq rasmi shunday ishlanadi.

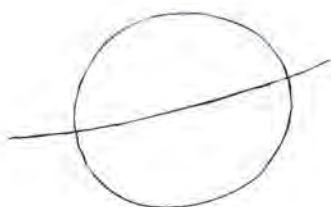

1

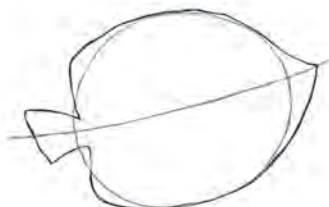

2

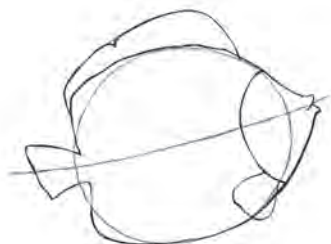

3



4

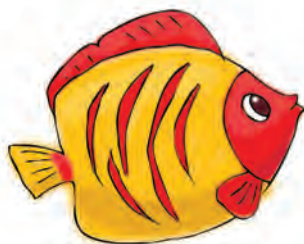

5



«IKKI ECHKI» ERTAGI ASOSIDA HAYKAL ISHLASH



Echki haykali shunday ishlanadi

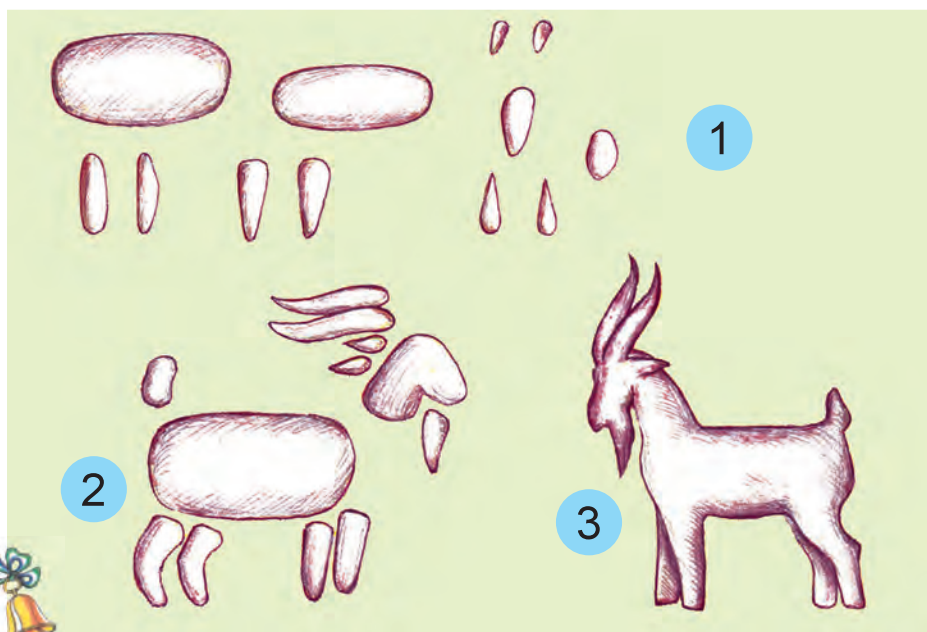

AVTOMASHINA RASMINI ISHLASH



Mashinalarning shakllari va ranglariga e'tibor bering. Ular har xil bo'ladi, nomlarini ayting.

Avtomashina rasmi quyidagicha chiziladi va bo'yaladi:

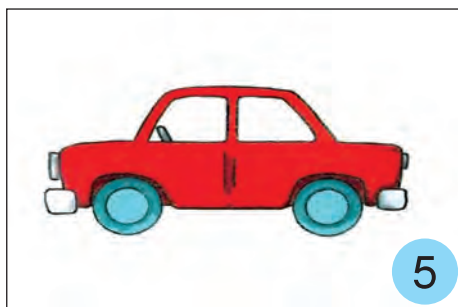
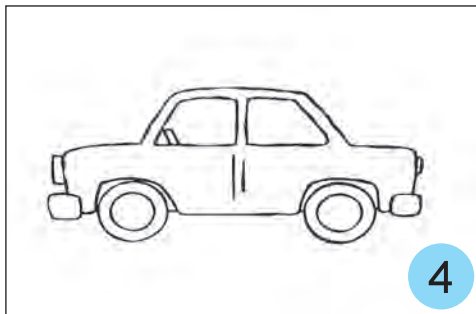
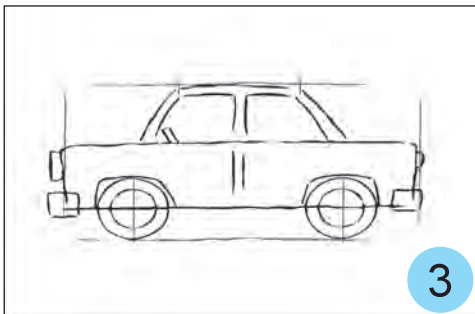
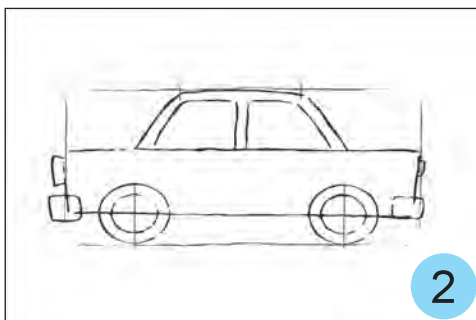
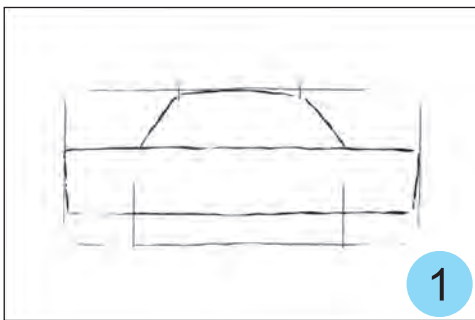

Endi avtomashina rasmini ishlang.

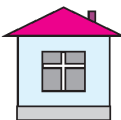

Sinfda boshlagan ishingizni yakuniga yetkazing.



QISH FASLINI IDROK ETISH

Quyidagi rasmda qish fasli tasvirlangan.



I.I.Shishkin. **Qish.**



Rustam Xudoyberganov. **Qish.**

Yuqoridagi rasmda qish fasli tasvirlanganligini qanday bilish mumkin?

Rasmda nimalar tasvirlangan?



Qish manzarasini kuzating.

«QISH» MAVZUSIDA RASM ISHLASH



Kuzatganlaringiz asosida qish manzarasi rasmini ishlang.



Sinfda boshlagan ishingizni nihoyasiga yetkazing.



XO'TIK HAYKALINI ISHLASH



Bu haykalchalar loydan ishlangan.

Siz avval toychoq haykalchasini ishlagan edingiz. Uni qanday ishlagan bo'lsangiz xo'tik haykalchasini ham shunday ishlaysiz.

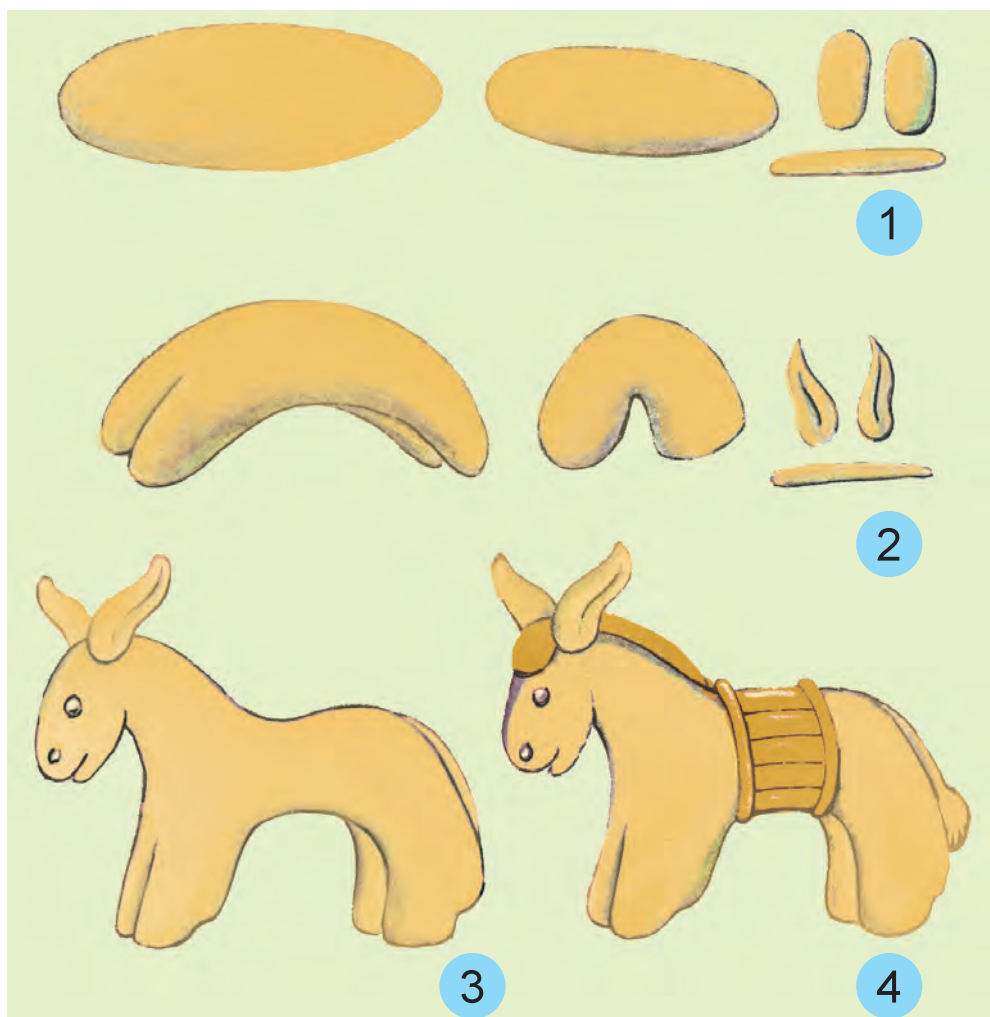

Xo'tik haykalchasini plastilin yoki loydan ishlashga kirishing.



Sinfda boshlagan ishingizni yakuniga yetkazing.



YELKANLI QAYIQCHA RASMINI ISHLASH



Qayiqcha rasmi quyidagi tartibda chiziladi va bo'yaladi.

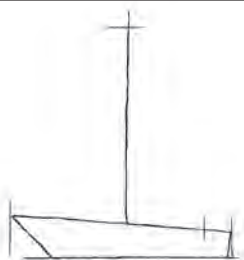

1



2



3



4

Siz ham yelkanli qayiqcha rasmini ishleng.

«UCH TULKI» ERTAGI ASOSIDA RASM ISHLASH

Ertakning mazmuni quyidagicha: Qashqa laqabli quyon eshagini minib, xo‘tigini ergashtirib o‘rmonga yo‘l oladi. Do‘stlari o‘rmonda ayyor tulkilar borligini aytib, uni ogohlantirishadi. Qashqa ularning gapiga kirmaydi. O‘rmonda u dastlab ota tulkiga xo‘tigini, so‘ng ona tulkiga eshagini o‘g‘irlatadi.



Aldangan quyon ko'l yoqasida yig'lab o'tirgan tulkichaga duch keladi va undan nima sababdan yig'layotganligini so'raydi.

Tulkicha hamyoni suvga tushib ketganligini, agar hamyonni suvdan olib chiqib bersa yuz tangasini unga berishini aytadi. Quyon yuz tangaga eshak sotib olish xayolida kiyimlarini yechib suvga sho'ng'iydi. Fursatdan foydalangan tulkicha uning kiyimlarini olib ketadi.

Qashqa hamyonni topa olmay suvdan chiqsa, kiyimlari yo'q. Uchta tulkiga aldanganini sezgan quyon o'rmonzorga yolg'iz bormaydigan bo'libdi.



Quyvon va tulki tasvirlari quyidagi bosqichlarda ishlanadi:

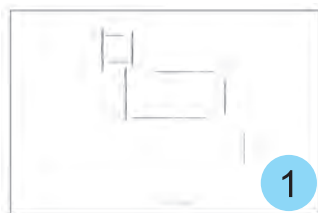
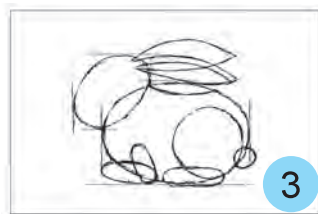
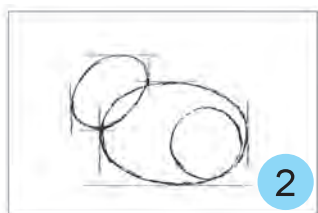
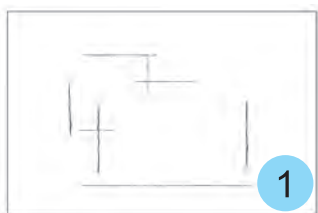

Ertak
ishlang.

mazmuni

asosida

rasm



Sinfda
yakuniga

boshlagan
yetkazing.

ishingizni



FIL HAYKALCHASINI ISHLASH

Siz avval turli haykalchalar ishlagan edingiz. Ularni qanday ishlagan bo'lsangiz, fil haykalchasini ham shu tartibda quyidagi bosqichlarda ishlaysiz.

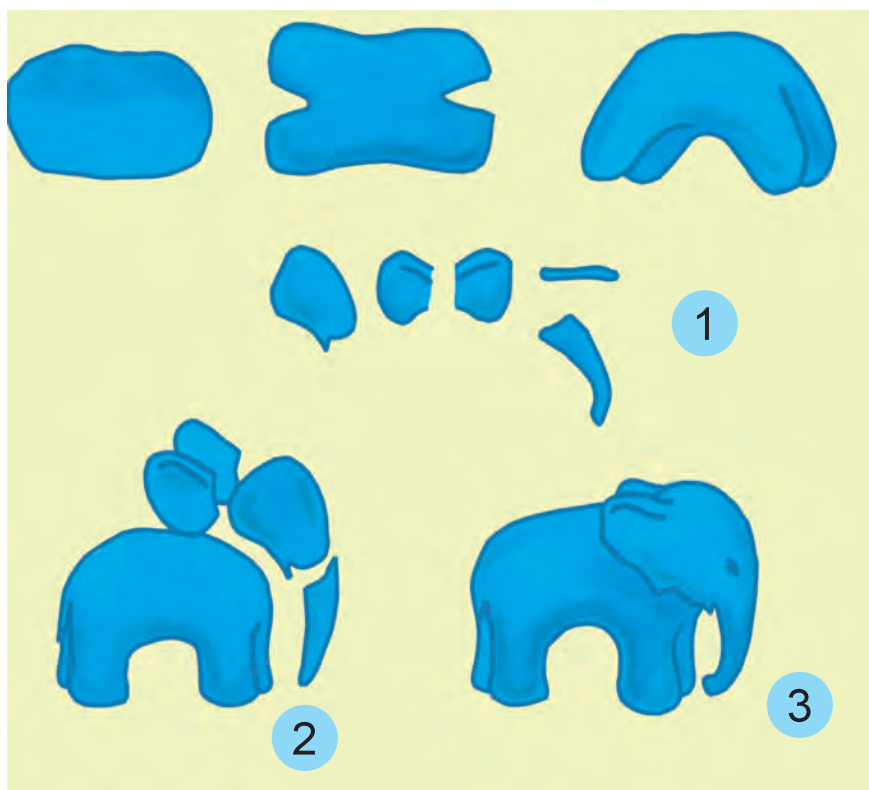

Fil haykalini loy yoki plastilindan ishlang.



Boshqa biror bir hayvonning haykalchasini ishlang.



SAMOLYOT RASMINI ISHLASH



Samolyotlar har xil bo'ladi.

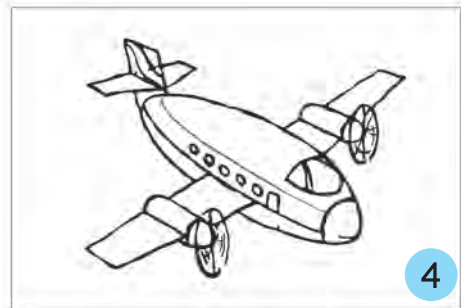
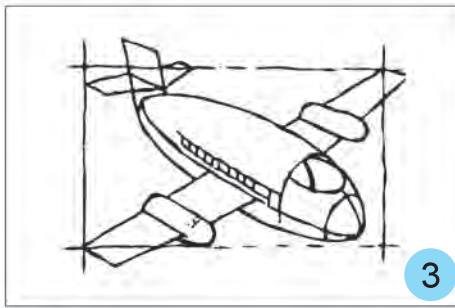
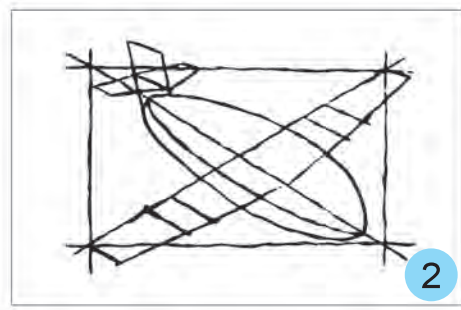
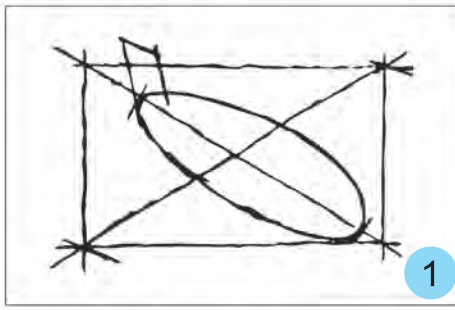

Samolyot rasmini yuqorida ko'rsatilgan chizmalar bo'yicha islang.

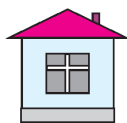

Sinfda boshlagan ishingizni yakuniga yetkazing.



HAVO SHARI RASMINI ISHLASH



1

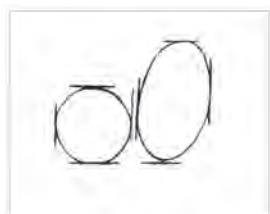

2

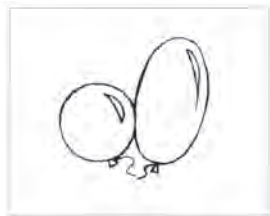

3



4



Yuqoridagi havo sharlarini chizing va bo'yang.



Boshqa shakldagi va rangdagi sharlar rasmini ishlang.

BAHOR FASLINI IDROK ETISH



Isaak Levitan. **Bahor.**



O'rol Tansiqboyev. **Tog'da.**

Bahor fasli ko'rinishlarini kuzating.



«O'LKAMIZDA BAHOR» MAVZUSIDA RASM ISHLASH



Rustam Xudoyberganov. **Bog'aro bahor.**

Asarni yaxshilab kuzating, unda nimalar tasvirlanganligini gapirib bering.

Gullayotgan daraxtning rasmini ishla-
moqchi bo'lsangiz, quyidagi namunalarga
e'tibor bering.



Tengdoshingiz ishlagan rasm.
Gullagan daraxt rasmini ishlang.



Bahorgi tabiat manzarasi quyidagi bos-
qichlarda chiziladi:

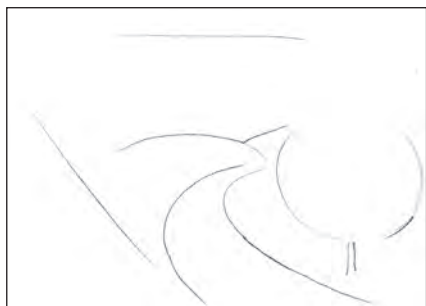

1



2



3

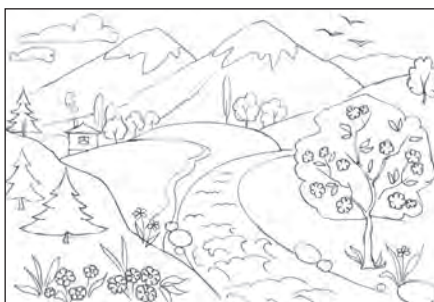

4



Bahorgi tabiat manzarasi rasmini
chizing.



Sinfda ishlagan bahorgi tabiat man-
zarasini davom ettiring va bo'yang.

GULLAR RASMINI ISHLASH

Bahorda ochilgan gullar o'z shakli va rangi bilan odamlarni maftun etadi. Ayniqsa, binafsha, lolaqizg'aldoq, momaqaymoq, gul-safsar, atirgul kabi rang-barang gullar odamlarni zavqlantiradi.



G'afur Abdurahmonov.
Qizil karnaygulli natyurmort.



Laylo Salimjonova. **Gullar.**



Tengdoshingiz ishlagan rasm.

Rasmda qanday gullar va nimalar tasvirlanganligi hamda ishlatilgan ranglar haqida gapirib bering.

Quyidagi berilgan momaqaymoq gulini yaxshilab kuzating. Uning bo'yi, guli, bargining shakli va rangini aniqlang.



Momaqaymoq gulining rasmi quyidagicha chiziladi:



Momaqaymoq guli rasmini ishlang.



KAPALAK RASMINI ISHLASH

Siz rang-barang kapalaklarning guldangulga qo'nib uchishini ko'p ko'rgansiz. Kapalaklar katta-kichik va har xil rangda bo'ladi.



Kapalak rasmi quyidagi bosqichlarda ishlanadi:

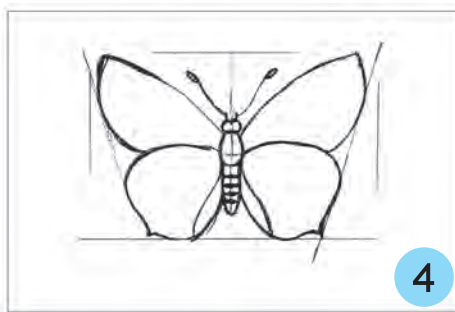
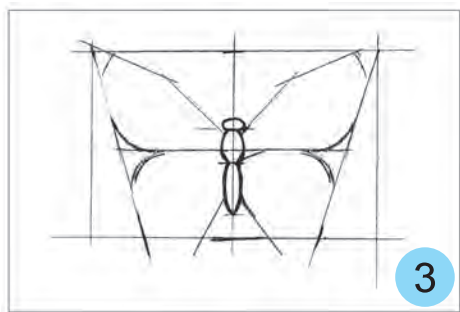
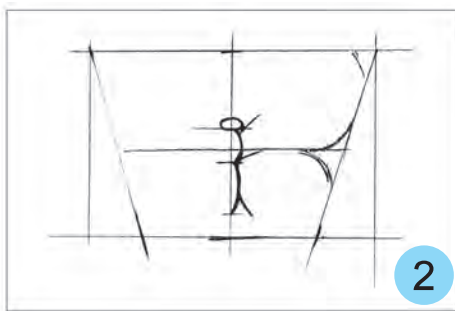
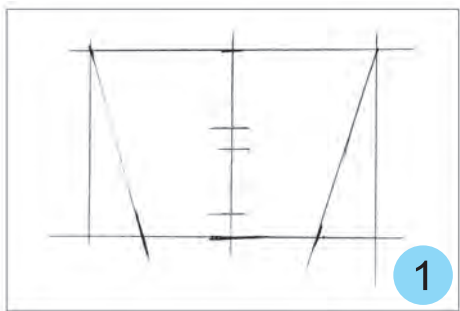

Kapalak rasmini ishlash bosqichlarini diqqat bilan kuzating va uning rasmini islang.

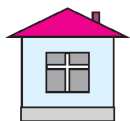

O'zingiz yoqtirgan kapalak rasmini chizing va bo'yang.



TO‘TIQUSH RASMINI ISHLASH

To‘tilarning dunyoda juda ko‘p turlari bor. Ular katta-kichik, turli rangda, nihoyatda chiroyli bo‘ladi.

Rasmdagi to‘tilarni yaxshilab kuza-ting, ularning tuzilishi, shakli, katta-kichikligi, rangi qandayligini gapirib bering.



Endi rasm chizishga kirishsangiz bo‘ladi. Avvalo to‘ti rasmini qog‘ozning qaysi joyiga chizishingizni va uning katta-kichikligi qanday bo‘lishini belgilab oling. To‘tini xohlagan ranglaringizga bo‘yashingiz mumkin.

To'tiqush rasmi quyidagi bosqichlarda chiziladi.



Siz ham to'tiqush rasmini ishleng.



1. O'zingiz bilgan boshqa qushning rasmini chizing va bo'yang.

2. Kelgusi darsga yil davomida ishlagan eng yaxshi rasm va haykallaringizni ko'rgazma uchun olib keling.



MUNDARIJA

Tasviriy san'at turlari	3
Rassomning ish qurollari	7
Chiziqlar va shakllar	10
Bo'yoqlar va ranglar	13
Bayroqcha rasmini ishlash	15
Soat rasmini ishlash	16
Kuz faslini idrok etish	17
«Kuz» mavzusida rasm ishlash	19
Barglar rasmini ishlash	20
Barglardan tasvir va shakllar hosil qilish	22
Haykal ishlash	23
Akvariumdagi baliqlar rasmini ishlash	26
«Ikki echki» ertagi asosida haykal ishlash	28
Avtomashina rasmini ishlash	29
Qish faslini idrok etish	31
«Qish» mavzusida rasm ishlash	33
Xo'tik haykalini ishlash	34
Yelkanli qayiqcha rasmini ishlash	36
«Uch tulki» ertagi asosida rasm ishlash	37
Fil haykalchasini ishlash	40
Samolyot rasmini ishlash	41
Havo shari rasmini ishlash	43
Bahor faslini idrok etish	44
«O'lkamizda bahor» mavzusida rasm ishlash	45
Gullar rasmini ishlash	48
Kapalak rasmini ishlash	51
To'tiqush rasmini ishlash	53

Rahim Hasanov

TASVIRIY SAN'AT

1-sinf uchun darslik

Qayta ishlangan 16-nashri

Muharrir *A. Karimov*

Badiiy muharrir *Sh. Mirfayozov*

Texnik muharrir *D. Jalilov*

Musahhih *D. To'ychiyeva*

Kompyuterda sahifalovchi *H. Sharipova, B. Tuxtarov*

Nashriyot litsenziya raqami AI № 290. 04.11.2016.

2018-yil 27 martda bosishga ruxsat etildi. Bichimi 70x100^{1/16}.
Kegli 18 shponli. Arial garniturası. Ofset bosma usulida bosildi.

4,55 shartli bosma toboq. 4,8 nashr tobog'i.

Adadi 514274 nusxa. ___ raqamli buyurtma.

O'zbekiston Matbuot va axborot agentligining

G'afur G'ulom nomidagi nashriyot-matbaa ijodiy uyida chop etildi.

100128. Toshkent. Labzak ko'chasi, 86.

www.gglit.uz

info@gglit.uz